

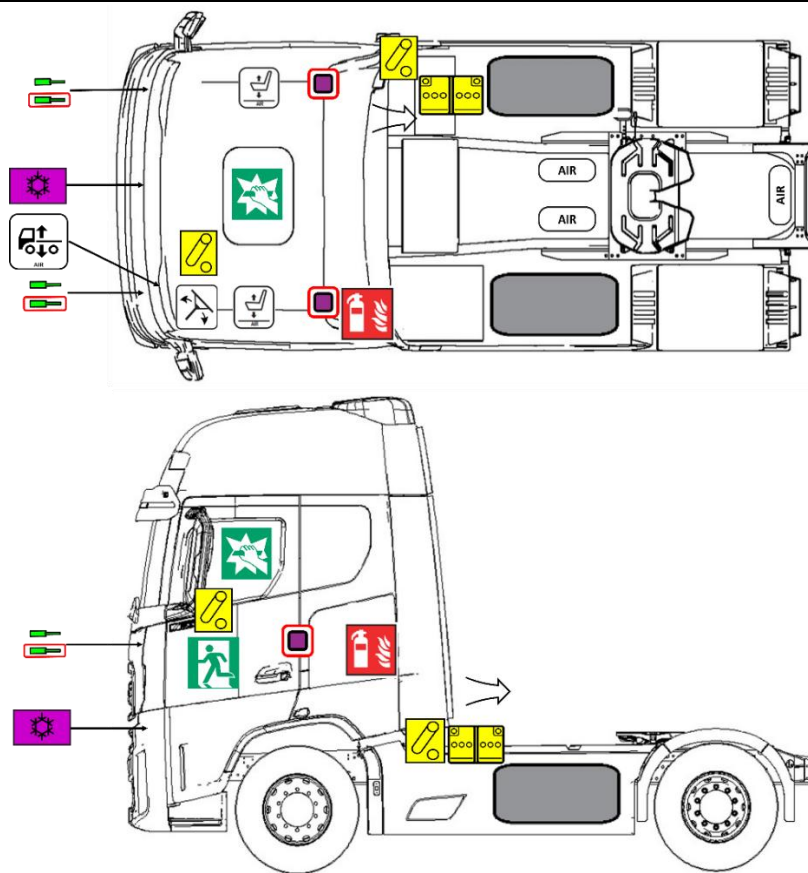









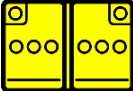





FORD LASTBILER

4x2 F-MAX Diesel

Produktionsstart: 2025



| | | | | | | |
|---|--|---|--|---|---|---|
|  Lav batterispænding |  Lufttank |  Rat, vippekontrol |  Justering af sædehøjde med luftsystem |  Luftindtag |  Sikkerhedsselefor strammer |  Gasfjeder / Forspændt fjeder |
|  Enhed til at slukke for strømmen i køretøjet |  Brændstoftankens indhold Diesel |  Komponent til klimaanlæg |  Pause for at få adgang |  Nødudgang |  Brandslukker |  Lastbil med højdekontrol, efter luftsystem |
| FORD 4x2 F-MAX Diesel | | | Identifikationsnummer FO_2025_625_001 | Versionsnummer 01 | Side nummer 1/4 | |

1. Identifikation/genkendelse

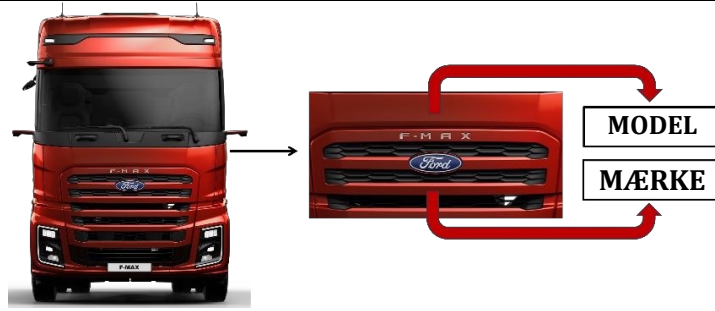

2. Immobilisering / stabilisering / løft

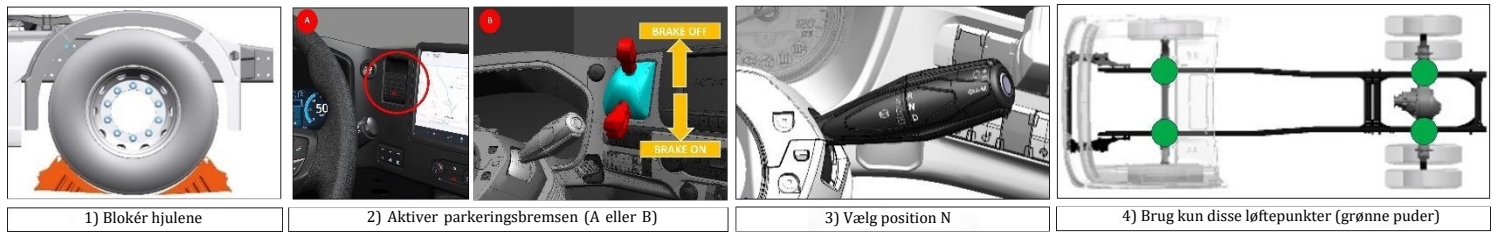

3. Deaktiver direkte farer/sikkerhedsforskrifter



Til lastbiler med startnøgle

(1): Sluk om muligt for startkontakten, og tag nøglen ud.

For lastbiler med start/stop-knap Tryk kort på knappen.

For lastbiler med ADR: Tryk på batteriets hovedafbryder (2). Drej batteriets hovedafbryder (3) eller (4) til OFF-position.

Bemærk: For lastbiler med ADR er hovedafbryderen en fysisk strømafbryder. Hovedafbryderen åbner ADR-relæerne for at frakoble 12 V-batterierne.



Placeringen af batterikassen er den samme i F-MAX-køretøjer. Dens placering ændres ikke. Billederne viser standardplaceringen (A). Batteriets hovedafbryder skal bruges til at slukke for spændingen i køretøjet.

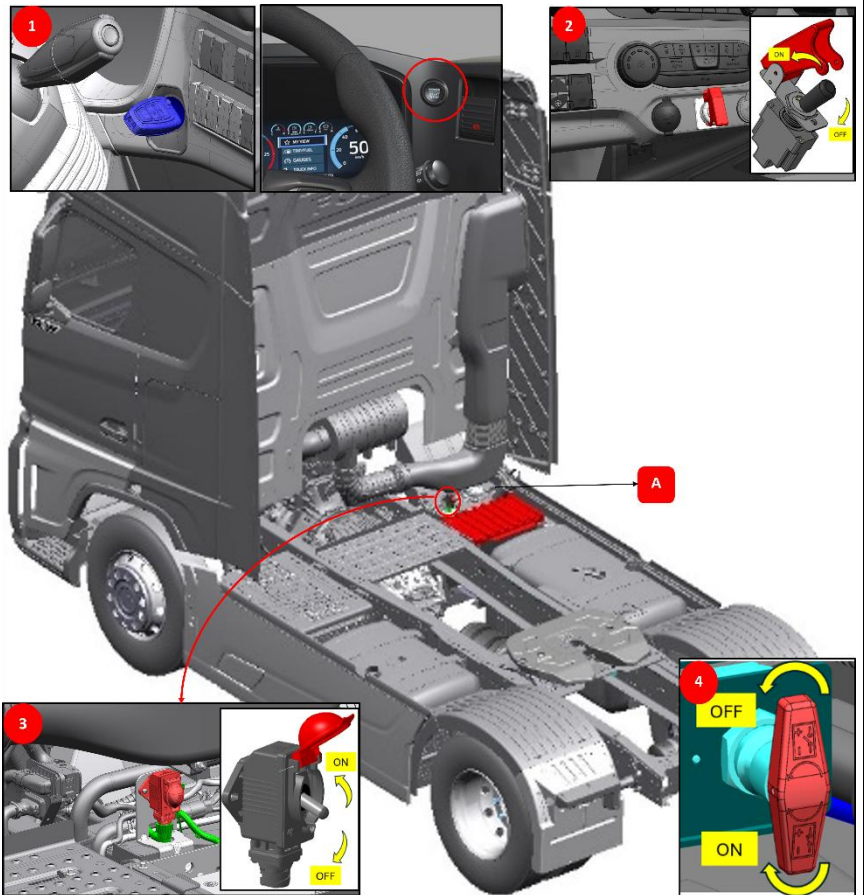

FORD 4x2 F-MAX Diesel

Identifikationsnummer

FO_2025_625_001

Versionsnummer

01

Side nummer

2/4

4. Adgang til passagererne







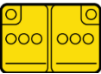

1. Gennem fører- eller passagerdør
2. Bryd gennem sidevinduet

A : Lamineret glas

B: Hærdet glas



5. Opbevaret energi / væsker / gasser / faste stoffer

| | | |
|---|---|---------------|
|  |  | 12V + 12V |
|  |  | 600 L + 250 L |
|  |  | 730 g |
|  |  | 85 L |

6. I tilfælde af brand



7. I tilfælde af nedsænkning



FORD 4x2 F-MAX Diesel

Identifikationsnummer

FO_2025_625_001

Versionsnummer

01

Side nummer

3/4

8. Bugsering/transport/opbevaring

1. Fastgørelsespunktet til slæbeøjet er placeret under den forreste kofanger.



2. Sluk for strømmen til køretøjet (se afsnit 3. Deaktivering af direkte farer/sikkerhedsforskrifter).

3. Hold dig væk fra brændbare og eksplosive materialer.

Tilladte metoder:

1. Bugsering. **(Bemærk: Brug kun det forreste trækøje til bugsering af køretøjet med alle hjul på jorden).**

2. Føreren til hjulene deaktiveres enten ved at afkoble kardanakslen (1) fra drivakslen (2) eller ved at fjerne drivakslerne (3).

3. Transport

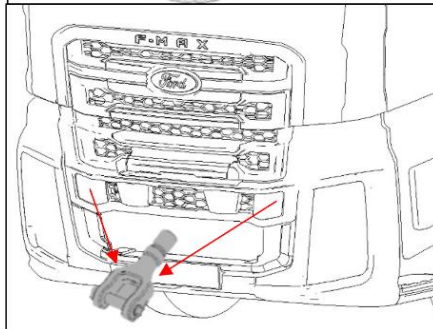
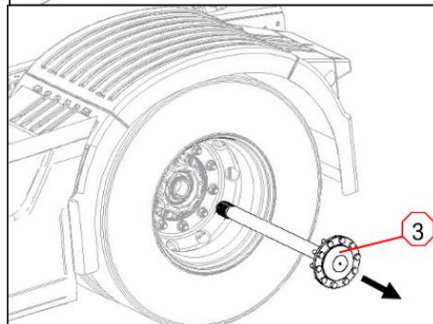
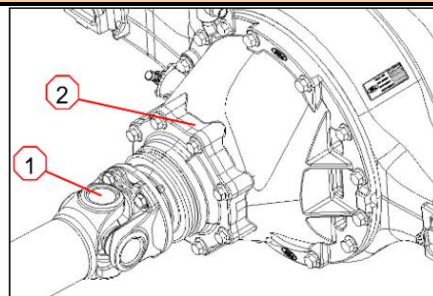











9. Vigtig yderligere information

 Udfør ikke nogen form for arbejde på en beskadiget lastbil uden passende personlige værnemidler (PPE).

Se førerens manual eller rednings- og bugseringsmanualen for mere detaljerede oplysninger.

10. Forklaring Anvendte piktogrammer

| | | | |
|--|-------------------------------|---|-------------------------------------|
|  | Farlig for menneskers sundhed |  | Irriterende stoffer |
|  | Ætsende stoffer |  | Gasser under tryk |
|  | Eksplosiv |  | Brug ABC-pulver til at slukke ilden |
|  | Miljømæssig risiko |  | Advarsel, elektricitet |
|  | Brandfarlig |  | Generelt advarselsskilt |
| FORD 4x2 F-MAX Diesel | | Identifikationsnummer FO_2025_625_001 | Versionsnummer 01 |
| | | | Side nummer 4/4 |