

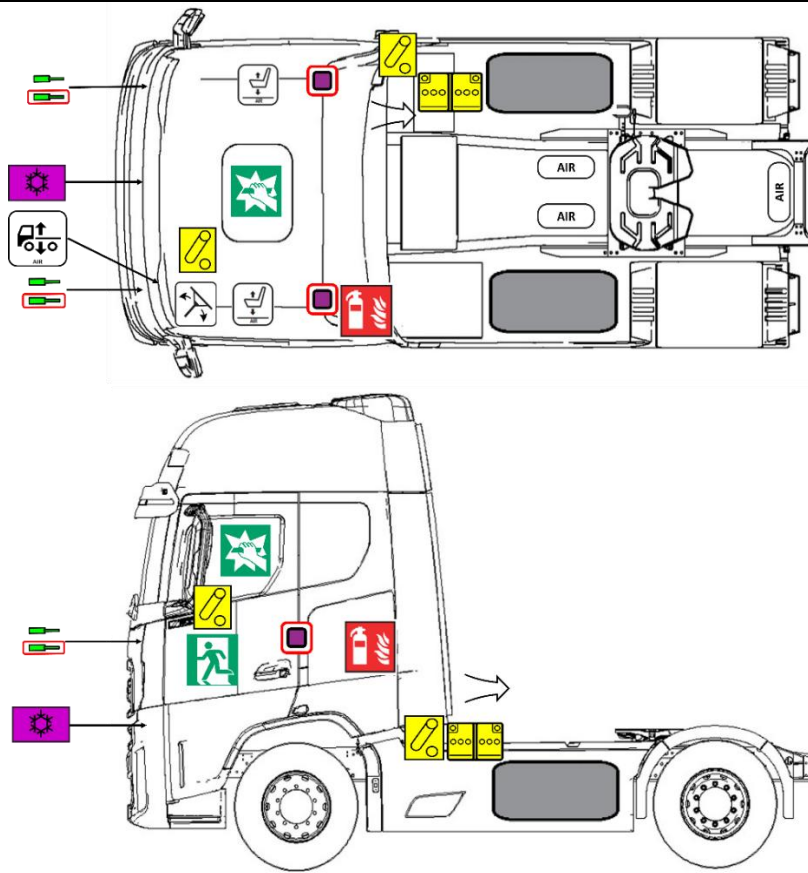











TRAKKIJET FORD

4x2 F-MAX Diesel

Bidu tal-Produzzjoni: 2025



 Vultagġ baxx tal-batterija	 Tank tal-arja	 Rota tal-istering, kontroll tal-inclinazzjoni	 Aġġustament tal-gholi tas-sedil permezz ta' sistema tal-arja	 Dhul tal-arja	 Pretensur ta' cinturin tas-sigurtà	 Strut tal-gass / Molla mghobbija minn qabel
 Apparat biex jitfi l-enerġija fil-vettura	 Kontenut tat-tank tal-fjuwil Diżil	 Komponent tal-arja kondizzjonata	 Pawża biex tikseb aċċess	 Hruġ ta' emerġenza	 Estintur tan-nar	 Trakk tal-kontroll tal-gholi, permezz ta' sistema tal-arja
FORD 4x2 F-MAX Diesel			Numru ta' Identifikazzjoni FO_2025_625_001	Numru tal-Verżjoni 01	Numru tal-Paġna 1/4	

1. Identifikazzjoni / Rikonoxximent



2. Immobilizzazzjoni / stabilizzazzjoni / irfigh

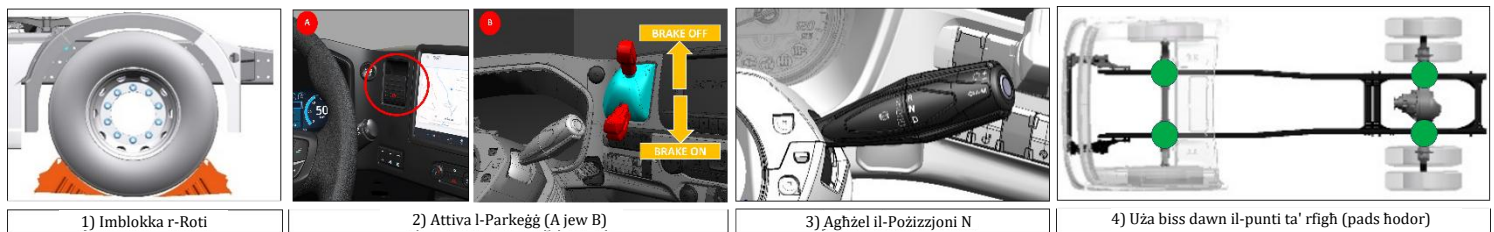

3. Iddizattiva l-perikli diretti / Regolamenti tas-sigurtà



Għal trakkijiet b'čavetta tal-istarter (1): Jekk possibbli, itfi s-swičċ tal-istarter u neħhi č-čavetta.

Għal trakkijiet bil-buttuna start/stop Aghfas il-buttuna fil-qosor.

Għal trakkijiet b'ADR: Aghfas is-swičċ prinċipali tal-batterija (2). Dawwar is-swičċ prinċipali tal-batterija (3) jew (4) għall-pożizzjoni OFF.

Nota: Għal trakkijiet b'ADR, is-swičċ prinċipali huwa qtugħ fiziku tal-enerġija. Is-swičċ prinċipali jiftaħ ir-relays tal-ADR biex jiskonnnettja l-batteriji ta' 12 V.



Il-post tal-kaxxa tal-batterija huwa l-istess fil-vetturi F-MAX. Il-post tagħha ma jinbidilx. L-istampi juru l-pożizzjonament standard (A). Is-swičċ prinċipali tal-batterija għandu jintuża biex jitfi l-vultaġġ fil-vettura.

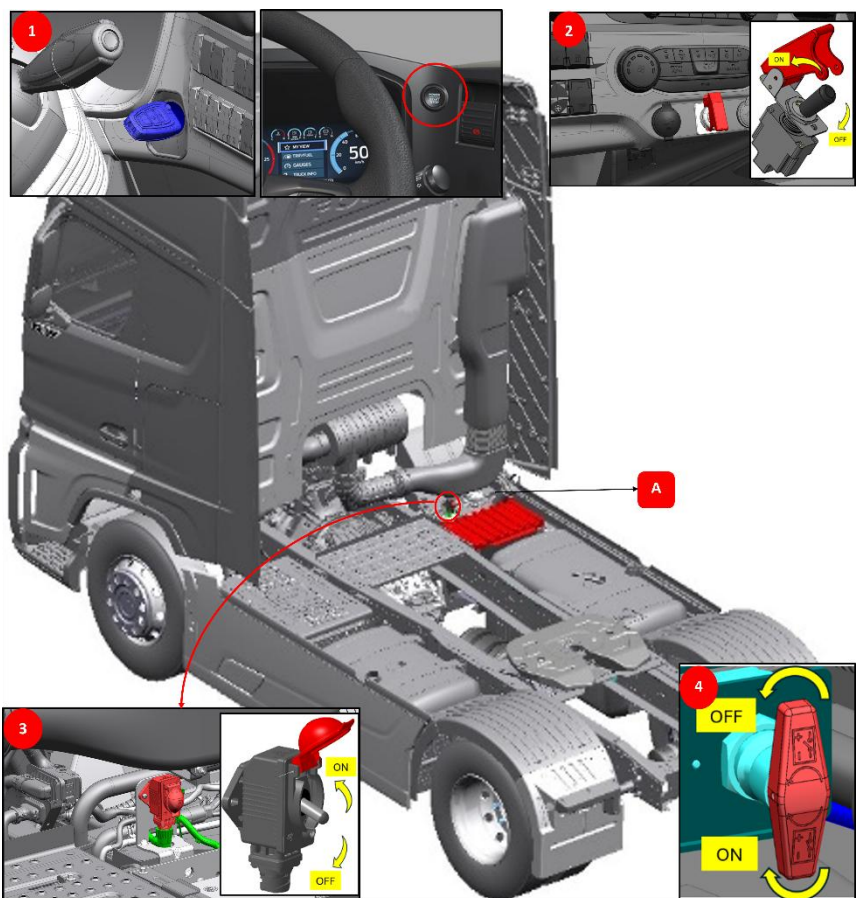

FORD 4x2 F-MAX Diesel

Numru ta' Identifikazzjoni

FO_2025_625_001

Numru tal-Verżjoni

01

Numru tal-Paġna

2/4

4. Aċċess għall-passiġġieri

1. Mill-bieba tas-sewwieq jew tal-passiġġier
 2. Kisser it-tieqa tal-ġenb
- A : Hġieg Laminat
B: Hġieg Ittemprat

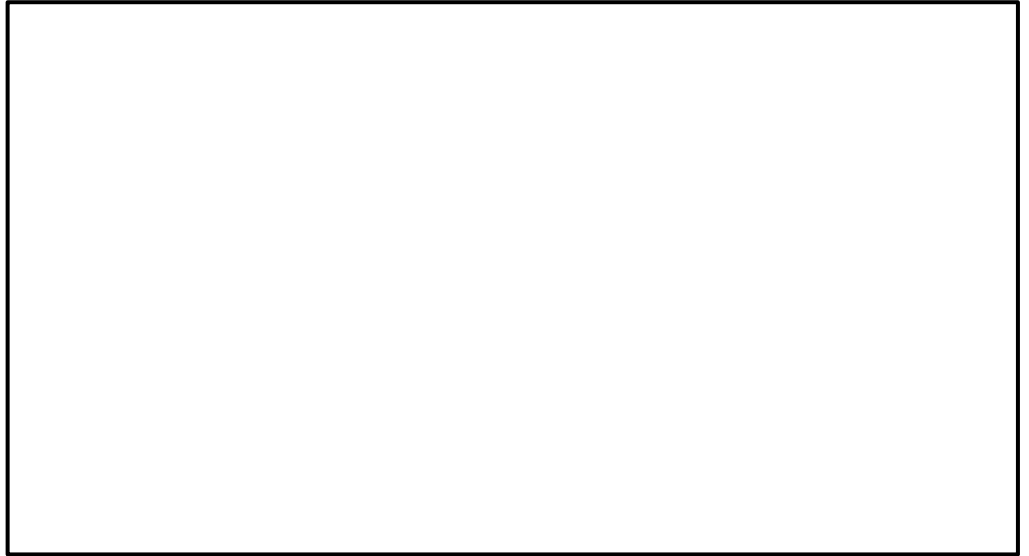

5. Energija maħzuna / likwidi / gassijiet / solidi

		12V + 12V
		600 L + 250 L
		730 g
		85 L

6. F'każ ta' nar

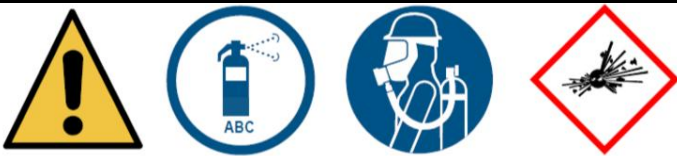

7. Fil-każ ta' gharghar



FORD 4x2 F-MAX Diesel

Numru ta' Identifikazzjoni

FO_2025_625_001

Numru tal-Verżjoni

01

Numru tal-Pagna

3/4

8. Irmonk/trasport/ħażna

1. Il-punt ta' twaħhil tal-għajn tal-irmonk jinsab taħt il-bamper ta' quddiem.



2. Itfi l-enerġija tal-vettura (Ara t-taqsim 3. Iddizattiva l-perikli diretti / regolamenti tas-sigurtà).

3. Żomm 'il bogħod minn materjali fġammabbli u splussivi.

Metodi Permessi:

1. Irmonk. **(Nota: Uża biss l-għajn tal-irmonk ta' quddiem għall-irmonk tal-vettura bir-roti kollha mal-art).**

2. Is-sewwieq għar-roti jiġi diżattivat billi jew jinħall ix-xaft tal-iskrun (1) mill-fus misjuq (2) jew billi jitneħħew ix-xaftijiet tas-sewqan (3).



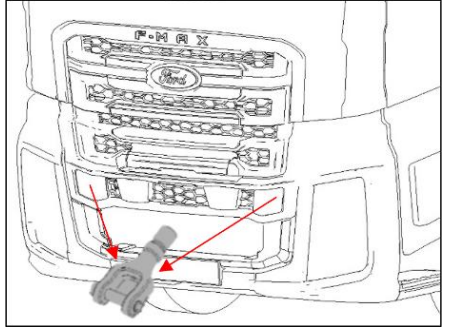
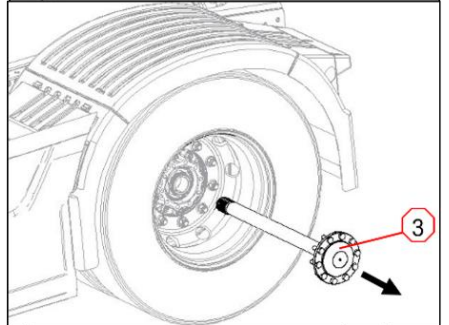
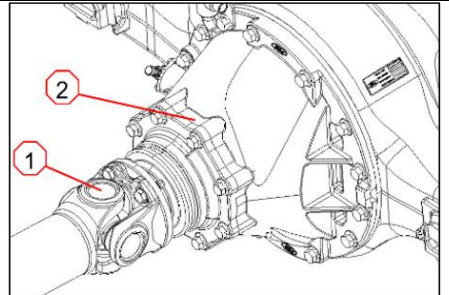







3. Trasport



9. Informazzjoni addizzjonali importanti

 Twettaqx xi operazzjoni fuq trakk bil-ħsara mingħajr Tagħmir Protettiv Personali (PPE) xieraq.
Ara l-manwal tas-sewwieq jew il-manwal tas-salvataġġ u l-irmonk għal aktar informazzjoni dettaljata.

10. Spjegazzjoni tal-Pittogrammi Użati

	Perikoluż għas-saħħa tal-bniedem		Irritanti
	Korrożivi		Gassijiet taħt pressjoni
	Splussiv		Uża trab ABC biex titfi n-nar
	Periklu ambjentali		Twissija, Elettriku
	Fġammabbli		Sinjal ta' twissija ġenerali
FORD 4x2 F-MAX Diesel		Numru ta' Identifikazzjoni FO_2025_625_001	Numru tal-Verżjoni 01
			Numru tal-Pagna 4/4